

MERCER INVINCIBLE HEAVY DUTY EXPANSION JOINTS

Series
**500, HT500,
600 & HT600**

COMPLETELY VERSATILE HAND-BUILT HEAVY DUTY EXPANSION JOINTS

PERFORMANCE FEATURES

- Pressures, vacuum ratings and temperature tolerance as detailed inside
- Minimum 3 to 1 safety factor, rated to burst pressure
- High temperature resistant fabric reinforcement for operating temperatures up to 400°F
- Components are pressure cured, resulting in structurally sound, long service life
- Optional exterior coat of Hypalon® paint provides additional protection against ozone weathering and chemical exposure

CONSTRUCTION FEATURES

- Sizes range 11/2" to 144" diameter
- Manufactured in one to four arches or more in standard or longer lengths as required
- Choice of eight liner elastomers
- Choice of cover to match liner materials or different materials for superior resistance to external conditions
- Baked Enamel, Galvanized Ductile Iron, Carbon or Stainless Steel Split Backup Rings
- 150 lb ASA drilling is standard. Other drillings or completely customized drillings as required. Opposite flanges can have different drillings to serve as transition pieces
- Reinforcement—Spiral steel wire or solid rings
- Hand-built to your exact specifications
- Can be built with permanent offset to compensate for existing or designed piping misalignment

SERIES 500

The Invincible 500 is our most rugged expansion joint. They are all hand-built by our skilled craftsmen. The 1/4" minimum thickness solid elastomer tube is continuous with the flange face. Multiple plies of rubber impregnated high strength polyester or nylon tire cord form the first pressure reinforcement over the tube. Arch swell in response to pressure and arch migration are virtually eliminated by criss-crossed layers of reinforcement that pass over the arch and around steel or ductile iron rings embedded on both sides at the base of the arch. Body swell is controlled by high strength fabric or spiral steel wire. Large diameter joints are often built with steel rings in place of the wire when in addition to internal pressure, external pressure resistance is important. External pressure may come from deep burial, shallow embankment under roadways or joints inside tanks.



Uncured rubber is used to fill the voids between the spiraled wire or steel rings. A minimum of two additional plies provide protection to the carcass and the cover rubber layer is a minimum of 1/8". All of the layered reinforcement and cover materials are carried through the full faced flanges.

Flanges are brought to thickness by heavy duty clamps that close the steel flange forms. The body is pressure wrapped by layers of nylon tape. The joint is cured in a pressurized thermostatically controlled steam chamber or in an oven for optimum performance.

After the wraps and forms are removed, the final product is a tough homogeneous expansion joint customized to safely handle the intended service. A variety of tube, cover and carcass elastomers are available and selected to provide superior chemical and aging resistance in temperatures ranging from -30° to 250°F (See Bulletin CRG-MR1).

SERIES HT500

The Invincible HT500 has all the construction features of the 500 combined with High Temperature capability. DuPont™ Kevlar® or other heat resistant fabrics replace the polyester or nylon. The tube and cover are either EPDM or Viton® for full pressure service up to 350°F and 400°F respectively.

SERIES 600

The Invincible 600 has a built in solid steel ring locked in place by reinforcement materials at the arch crown. This enables the 600 to handle vacuum conditions in excess of those listed for the 500 in multiple arch joints.

SERIES HT600

The Invincible HT600 has all the construction features of the 600 combined with High Temperature capability. DuPont™ Kevlar® or other heat resistant fabrics replace the polyester or nylon. The tube and cover are either EPDM or Viton® for full vacuum service up to 350°F and 400°F respectively.

BACKUP RINGS

Standard expansion joints are furnished with ASA-150 backup rings. Series ASA-300, DIN, PN, JIS and British Standards are also available, but sometimes at higher cost. Check factory for pricing.

FILLED ARCHES

All of the styles are available with filled arch construction for use with heavy slurries. The continuous liner prevents material build-up in the arch. Filled arch joints have 50% of open arch movements.



CUSTOM DESIGNS

Published dimensional data is for "Standard" joints. However, about 50% of Mercer business consists of building custom joints such as:

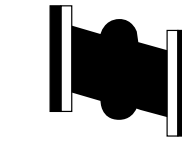

OFFSET JOINTS

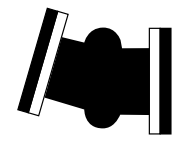

UNPARALLEL FACES

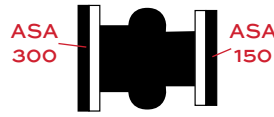

MISMATCHED FLANGES

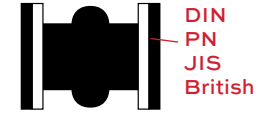

OVERSEAS FLANGES

Mercer can custom design joints for most special requirements.

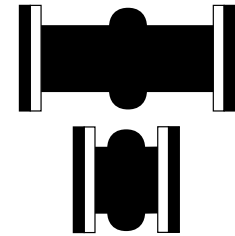

LONGER OR SHORTER FACE TO FACE

SPRING MOUNTED EQUIPMENT & OTHER UNANCHORED APPLICATIONS

Series 500, HT500, 600 & HT600 expansion joints used as noise & vibration dampeners installed in unanchored piping will overextend in response to system pressure & must be installed with control rod assemblies.

Adjust the spring mountings so the equipment is at proper elevation and level. Leave a space between pipe flanges equal to the expansion joint's face to face length shown on pages 9-93 - 9-96. Install expansion joint and control rod assemblies. Control rod stop nuts should be finger tight against gusset plate. Lock in position with lock nut. Control rod assemblies will prevent extension of expansion joint & will not allow transfer of thrust load to spring supports of equipment and/or piping.

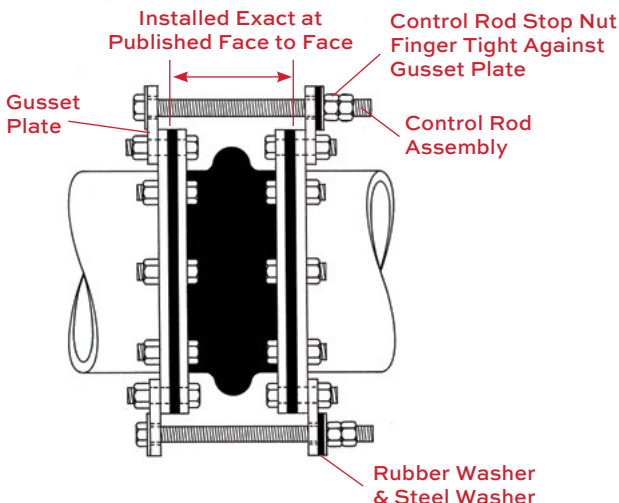

ANCHORED PIPING APPLICATIONS

Series 500, HT500, 600 & HT600 expansion joints used to compensate for thermal movement in properly anchored & guided piping systems generally do not require control rods, provided piping movements are within the allowables shown on pages 9-93 - 9-96.

If, as an added precaution, designers elect to use control rods in anchored systems, the expansion joint should be installed at its exact published face to face length. When control rod assemblies are installed, the stop nuts should be backed away from the gusset plate a distance equal to the allowable extension of the joint (See tables, pages 9-93 - 9-96). This will prevent overextension of the joint. Compression sleeves should also be employed. The compression sleeves are cut at the factory to the proper length to prevent over compression.

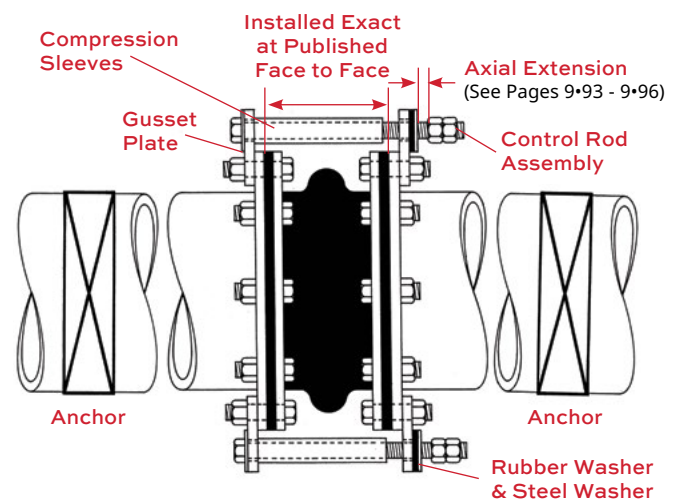

**Series 500, HT500,
600 & HT600**

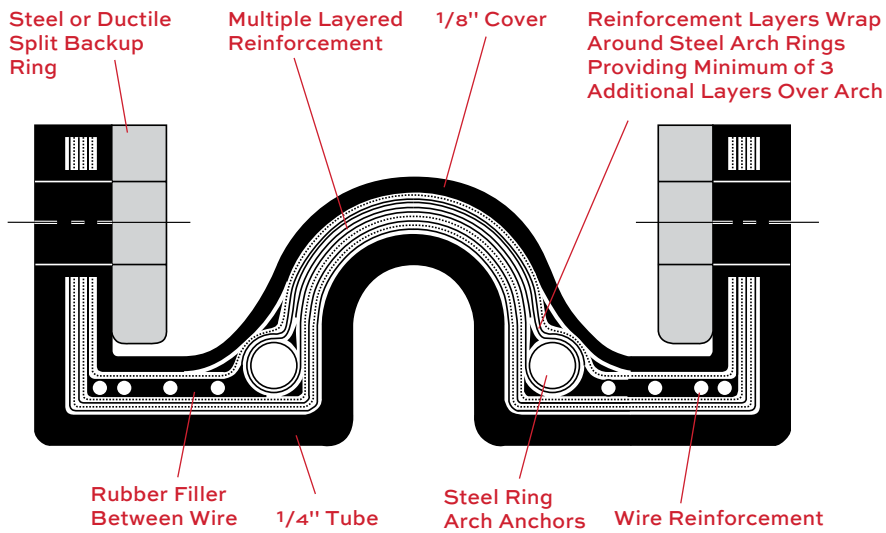
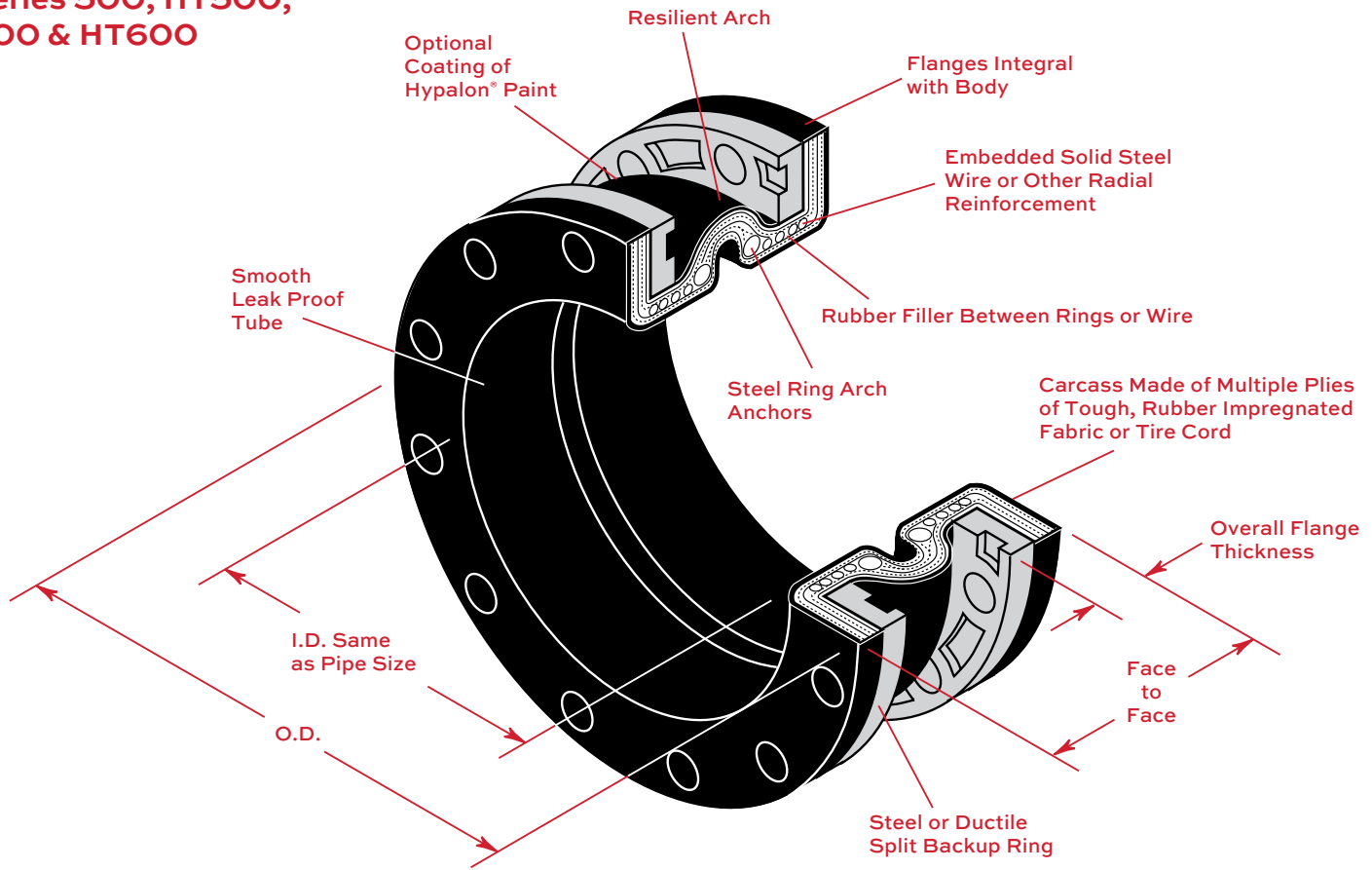

SERIES 500 & 600
MATERIAL AVAILABILITY
& OPERATING TEMPERATURES

Series 500 & 600	Standard Materials		Max. Oper. Temp.
	Tube	Cover	
B	Butyl	Butyl	250°F
E	EPDM	EPDM	250°F
H	Hypalon®	Hypalon®	225°F
HN	Hypalon®	Neoprene	225°F
N	Neoprene	Neoprene	225°F
NH	Neoprene	Hypalon	225°F
Ni	Nitrile	Nitrile	210°F
NiN	Nitrile	Neoprene	210°F
NR	Neoprene	Natural	180°F
R	Natural	Natural	180°F
RN	Natural	Neoprene	180°F
V	Viton®	Viton®	250°F

SERIES HT500 & HT600
MATERIAL AVAILABILITY
& OPERATING TEMPERATURES

Series HT500 & HT600	High Temperature Material Cover	Max. Oper. Temp.
	K-E	
K-V	Viton®	400°F

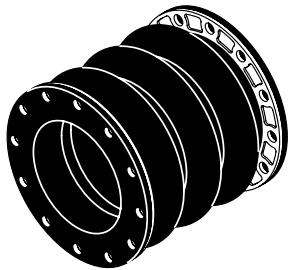

TYPICAL MULTIPLE ARCH CONSTRUCTION

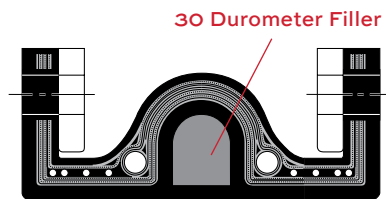

OPTIONAL FILLED ARCH CONSTRUCTION

1 ARCH
STYLE 501 & HT501

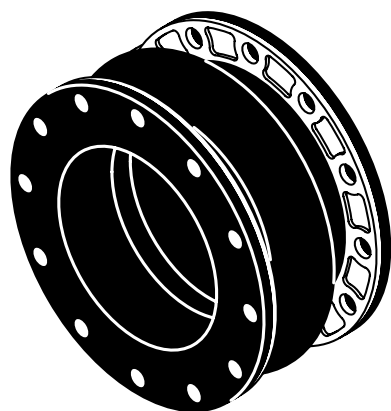

CAUTION

1. Do not install any of the products in this bulletin at pressures or temperatures higher than the published ratings.
2. Series 500, HT500, 600 and HT600 must be installed against standard 1/16" raised faced or flat faced flanges. Do not install them against recessed flanges such as Victaulic without calling the factory for proper steel filler flanges. If our rubber flanges do not have full bearing, the expansion joint will be damaged and leak or fail.
3. Pipe system flanges must be smooth and flat. Screw-in brass inserts such as those used in check valves can damage the rubber faces if they project above the cast flange face.
4. Water-type check valves must exactly center on the rubber flanges. Valve O.D. and I.D. must conform to raised face dimensions.
5. Use control rods as listed on page 9*91.
6. Check Chemical Resistance Guide CRG-MR1 (page 9*59) for service elastomer compatibility.
7. Follow installation instructions on page 9*97.

STYLE 501 & HT501 OPEN ARCH DIMENSIONS, ALLOWABLE MOVEMENTS* & PRESSURES†

Pipe Size (in)	Flange Outside Dia. (in)	Face to Face (in)	Overall Flange Thickness (in)		Bolt Circle Dia. (in)	No. of Holes	Bolt Hole Dia. (in)	Allowable Movements					Rated Working Pressure [†] (psig)	Minimum Burst Pressure [†] (psig)	Vacuum Rating (in Hg)
			Steel	Ductile				Axial Compression (in)	Axial Extension (in)	Lateral Deflection (in)	Degrees Angular (degrees)	Degrees Torsional (degrees)			
1 1/2	5	6	7/8	1	37/8	4	5/8	3/4	1/2	1/2	18.5	3	250	750	30
2	6	6	7/8	1	43/4	4	3/4	3/4	1/2	1/2	14.5	3	250	750	30
2 1/2	7	6	7/8	1	51/2	4	3/4	3/4	1/2	1/2	11.5	3	250	750	30
3	7 1/2	6	7/8	1	6	4	3/4	3/4	1/2	1/2	10.0	3	250	750	30
4	9	6	7/8	1	7 1/2	8	3/4	3/4	1/2	1/2	7.5	3	250	750	30
5	10	6	7/8	1	8 1/2	8	7/8	3/4	1/2	1/2	6.0	3	250	750	30
6	11	6	7/8	1	9 1/2	8	7/8	3/4	1/2	1/2	5.5	3	250	750	30
8	13 1/2	6	7/8	1	11 3/4	8	7/8	3/4	1/2	1/2	5.0	3	250	750	30
10	16	8	1	1 1/8	14 1/4	12	1	1	5/8	5/8	4.5	3	250	750	30
12	19	8	1	1 1/8	17	12	1	1	5/8	5/8	3.8	3	250	750	30
14	21	8	1	1 1/8	18 3/4	12	1 1/8	1	5/8	5/8	3.3	2	250	750	30
16	23 1/2	8	1	1 1/8	21 1/4	16	1 1/8	1	5/8	5/8	2.8	2	250	750	30
18	25	8	1 1/8	1 1/4	22 3/4	16	1 1/4	1	5/8	5/8	2.5	1	250	750	30
20	27 1/2	8	1 1/8	1 1/4	25	20	1 1/4	1	5/8	5/8	2.5	1	250	750	30
22	29 1/2	10	1 1/8	1 1/4	27 1/4	20	1 3/8	1 1/4	3/4	5/8	2.3	1	250	750	30
24	32	10	1 1/8	1 1/4	29 1/2	20	1 3/8	1 1/4	3/4	5/8	2.0	1	250	750	30
26	34 1/4	10	1 1/8	1 1/4	31 3/4	24	1 3/8	1 1/4	3/4	5/8	2.0	1	250	750	30
28	36 1/2	10	1 1/8	1 1/4	34	28	1 3/8	1 1/4	3/4	5/8	2.0	1	250	750	30
30	38 3/4	10	1 1/8	1 1/4	36	28	1 3/8	1 1/4	3/4	5/8	2.0	1	250	750	30
34	43 3/4	10	1 1/8	1 1/4	40 1/2	32	1 5/8	1 1/4	3/4	5/8	1.8	1	250	750	30
36	46	10	1 1/8	1 1/4	42 3/4	32	1 5/8	1 1/4	3/4	5/8	1.5	1	250	750	30
40	50 3/4	10	1 1/8	1 1/4	47 1/4	36	1 5/8	1 1/4	3/4	5/8	1.5	1	175	525	30
42	53	12	1 1/8	1 1/4	49 1/2	36	1 5/8	1 1/2	7/8	3/4	1.5	1	175	525	30
44	55 1/4	12	1 1/8	1 1/4	51 3/4	40	1 5/8	1 1/2	7/8	3/4	1.5	1	175	525	30
48	59 1/2	12	1 1/8	1 1/4	56	44	1 5/8	1 1/2	7/8	3/4	1.5	1	175	525	30
50	61 3/4	12	1 1/8	1 1/4	58 1/4	44	1 7/8	1 1/2	7/8	3/4	1.3	1	150	450	30
54	66 1/4	12	1 1/8	1 1/4	62 3/4	44	1 7/8	1 1/2	7/8	3/4	1.3	1	150	450	30
56	68 3/4	12	1 1/8	1 1/4	65	48	1 7/8	1 1/2	7/8	3/4	1.3	1	100	300	30
60	73	12	1 1/8	1 1/4	69 1/4	52	2	1 1/2	7/8	3/4	1.0	1	100	300	30
62	75 3/4	12	1 1/8	1 1/4	71 3/4	52	2	1 1/2	7/8	3/4	1.0	1	100	300	30
66	80	12	1 1/8	1 1/4	76	52	2	1 1/2	7/8	3/4	1.0	1	100	300	30
72	86 1/2	12	1 1/8	1 1/4	82 1/2	60	2	1 1/2	7/8	3/4	0.9	1	100	300	30
78	93	12	1 1/8	1 1/4	88 3/4	60	2 1/8	1 1/2	7/8	3/4	0.9	1	100	300	30
84	99 3/4	12	1 1/8	1 1/4	95 1/2	64	2 1/8	1 1/2	7/8	3/4	0.8	1	100	300	30
90	106 1/2	12	1 1/8	1 1/4	102 1/4	68	2 1/4	1 1/2	7/8	3/4	0.8	1	75	225	30
96	113 1/4	12	1 1/8	1 1/4	108 1/2	68	2 1/2	1 1/2	7/8	3/4	0.7	1	75	225	30
98	115 1/2	12	1 1/4	1 3/8	110 3/4	68	2 1/2	2 1/4	1	1 1/8	0.6	1	50	150	30
100	117 3/4	12	1 1/4	1 3/8	113	68	2 1/2	2 1/4	1	1 1/8	0.6	1	35	105	30
102	120	12	1 1/4	1 3/8	114 1/2	72	2 1/2	2 1/4	1	1 1/8	0.6	1	35	105	30
108	126 3/4	12	1 1/4	1 3/8	120 3/4	72	2 1/2	2 1/4	1	1 1/8	0.4	1	35	105	30
120	140 1/4	12	1 1/4	1 3/8	132 3/4	76	2 1/2	2 1/4	1	1 1/8	0.4	1	25	75	30
132	153 3/4	12	1 1/4	1 3/8	145 3/4	80	2 1/2	2 1/4	1	1 1/8	0.3	1	25	75	30
144	167 1/4	12	1 1/4	1 3/8	158 1/4	84	2 1/2	2 1/4	1	1 1/8	0.1	1	25	75	30

*Reduce movements 50% when using filled arches. †Higher pressure joints are special design- Advise factory of requirements.

2 ARCH
STYLE 502 & HT502, 602 & HT602

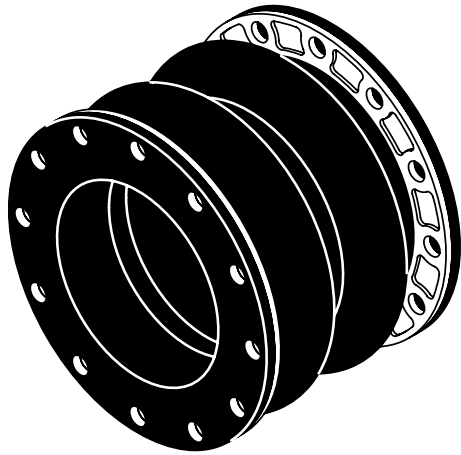

STYLE 502, HT502, 602 & HT602 OPEN ARCH DIMENSIONS, ALLOWABLE MOVEMENTS* & PRESSURES†

Pipe Size (in)	Flange Outside Dia. (in)	Face to Face (in)	Overall Flange Thickness (in)		Bolt Circle Dia. (in)	No. of Holes	Bolt Hole Dia. (in)	Allowable Movements					Rated Working Pressure [†] (psig)	Minimum Burst Pressure [†] (psig)	502, HT502 Vacuum (in Hg)	602, HT602 Vacuum (in Hg)
			Steel	Ductile				Axial Compression (in)	Axial Extension (in)	Lateral Deflection (in)	Degrees Angular (degrees)	Degrees Torsional (degrees)				
1 1/2	5	10	7/8	1	37/8	4	5/8	11/2	1	1	23.5	5	180	540	30	—
2	6	10	7/8	1	43/4	4	3/4	11/2	1	1	19.5	5	180	540	30	—
2 1/2	7	10	7/8	1	51/2	4	3/4	11/2	1	1	16.5	5	180	540	30	—
3	7 1/2	10	7/8	1	6	4	3/4	11/2	1	1	15.5	5	180	540	30	—
4	9	10	7/8	1	7 1/2	8	3/4	11/2	1	1	12.5	5	180	540	30	—
5	10	10	7/8	1	8 1/2	8	7/8	11/2	1	1	11.0	5	180	540	30	—
6	11	10	7/8	1	9 1/2	8	7/8	11/2	1	1	10.5	5	180	540	30	—
8	13 1/2	10	7/8	1	11 3/4	8	7/8	11/2	1	1	10.0	5	180	540	30	—
10	16	12	1	1 1/8	14 1/4	12	1	2	1 1/4	1 1/4	9.5	5	180	540	30	—
12	19	12	1	1 1/8	17	12	1 1/8	2	1 1/4	1 1/4	8.8	5	180	540	30	—
14	21	12	1	1 1/8	18 3/4	12	1 1/8	2	1 1/4	1 1/4	8.3	4	180	540	30	—
16	23 1/2	12	1	1 1/8	21 1/4	16	1 1/8	2	1 1/4	1 1/4	7.8	4	180	540	30	—
18	25	12	1 1/8	1 1/4	22 3/4	16	1 1/4	2	1 1/4	1 1/4	7.5	3	180	540	30	—
20	27 1/2	12	1 1/8	1 1/4	25	20	1 1/4	2	1 1/4	1 1/4	7.5	3	180	540	30	—
22	29 1/2	14	1 1/8	1 1/4	27 1/4	20	1 3/8	2 1/2	1 1/2	1 1/4	7.3	3	180	540	30	—
24	32	14	1 1/8	1 1/4	29 1/2	20	1 3/8	2 1/2	1 1/2	1 1/4	7.0	3	180	540	30	—
26	34 1/4	14	1 1/8	1 1/4	31 3/4	24	1 3/8	2 1/2	1 1/2	1 1/4	7.0	3	180	540	30	—
28	36 1/2	14	1 1/8	1 1/4	34	28	1 3/8	2 1/2	1 1/2	1 1/4	7.0	3	180	540	20	30
30	38 3/4	14	1 1/8	1 1/4	36	28	1 3/8	2 1/2	1 1/2	1 1/4	7.0	3	180	540	20	30
34	43 3/4	14	1 1/8	1 1/4	40 1/2	32	1 5/8	2 1/2	1 1/2	1 1/4	6.8	3	180	540	20	30
36	46	14	1 1/8	1 1/4	42 3/4	32	1 5/8	2 1/2	1 1/2	1 1/4	6.5	3	180	540	20	30
40	50 3/4	14	1 1/8	1 1/4	47 1/4	36	1 5/8	2 1/2	1 1/2	1 1/4	6.5	3	130	390	20	30
42	53	16	1 1/8	1 1/4	49 1/2	36	1 5/8	3	1 3/4	1 1/2	6.5	2	130	390	15	30
44	55 1/4	16	1 1/8	1 1/4	51 3/4	40	1 5/8	3	1 3/4	1 1/2	6.5	2	130	390	15	30
48	59 1/2	16	1 1/8	1 1/4	56	44	1 5/8	3	1 3/4	1 1/2	6.5	2	130	390	15	30
50	61 3/4	16	1 1/8	1 1/4	58 1/4	44	1 7/8	3	1 3/4	1 1/2	6.3	2	110	330	15	30
54	66 1/4	16	1 1/8	1 1/4	62 3/4	44	1 7/8	3	1 3/4	1 1/2	6.3	2	110	330	15	30
56	68 3/4	16	1 1/8	1 1/4	65	48	1 7/8	3	1 3/4	1 1/2	6.3	2	75	225	15	30
60	73	16	1 1/8	1 1/4	69 1/4	52	2	3	1 3/4	1 1/2	6.0	2	75	225	15	30
62	75 3/4	16	1 1/8	1 1/4	71 3/4	52	2	3	1 3/4	1 1/2	6.0	2	75	225	15	30
66	80	16	1 1/8	1 1/4	76	52	2	3	1 3/4	1 1/2	6.0	2	75	225	15	30
72	86 1/2	16	1 1/8	1 1/4	82 1/2	60	2	3	1 3/4	1 1/2	5.9	2	75	225	15	30
78	93	16	1 1/8	1 1/4	88 3/4	60	2 1/8	3	1 3/4	1 1/2	5.9	2	75	225	15	30
84	99 3/4	16	1 1/8	1 1/4	95 1/2	64	2 1/8	3	1 3/4	1 1/2	5.8	2	75	225	15	30
90	106 1/2	16	1 1/8	1 1/4	102 1/4	68	2 1/4	3	1 3/4	1 1/2	5.8	2	55	165	15	30
96	113 1/4	16	1 1/8	1 1/4	108 1/2	68	2 1/2	3	1 3/4	1 1/2	5.7	2	55	165	15	30
98	115 1/2	16	1 1/4	1 3/8	110 3/4	68	2 1/2	4 1/2	2	2 1/4	5.6	2	35	105	15	30
100	117 3/4	16	1 1/4	1 3/8	113	68	2 1/2	4 1/2	2	2 1/4	5.6	2	25	75	15	30
102	120	16	1 1/4	1 3/8	114 1/2	72	2 1/2	4 1/2	2	2 1/4	5.6	2	25	75	15	30
108	126 3/4	16	1 1/4	1 3/8	120 3/4	72	2 1/2	4 1/2	2	2 1/4	5.4	2	25	75	15	30
120	140 1/4	16	1 1/4	1 3/8	132 3/4	76	2 1/2	4 1/2	2	2 1/4	5.4	2	20	60	15	30
132	153 3/4	16	1 1/4	1 3/8	145 3/4	80	2 1/2	4 1/2	2	2 1/4	5.3	2	20	60	15	30
144	167 3/4	16	1 1/4	1 3/8	158 1/4	84	2 1/2	4 1/2	2	2 1/4	5.1	2	20	60	10	30

*Reduce movements 50% when using filled arches. †Higher pressure joints are special design- Advise factory of requirements.



3 ARCH
STYLE 503 & HT503, 603 & HT603

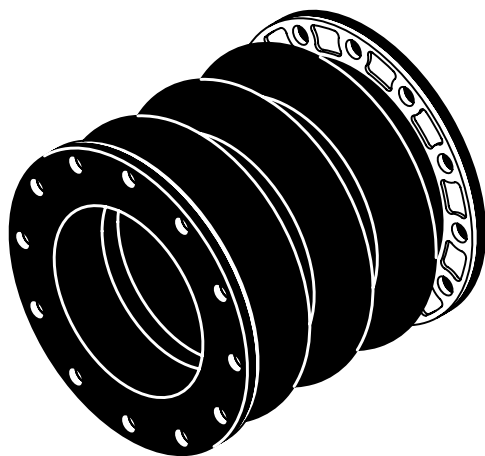

CAUTION

1. Do not install any of the products in this bulletin at pressures or temperatures higher than the published ratings.
2. Series 500, HT500, 600 and HT600 must be installed against standard 1/16" raised faced or flat faced flanges. Do not install them against recessed flanges such as Victaulic without calling the factory for proper steel filler flanges. If our rubber flanges do not have full bearing the expansion joint will be damaged and leak or fail.
3. Pipe system flanges must be smooth and flat. Screw-in brass inserts such as those used in check valves can damage the rubber faces if they project above the cast flange face.
4. Water-type check valves must exactly center on the rubber flanges. Valve O.D. and I.D. must conform to raised face dimensions.
5. Use control rods as listed on page 9•91.
6. Check Chemical Resistance Guide CRG-MR1 (page 9•59) for service elastomer compatibility.
7. Follow installation instructions on page 9•97.

STYLE 503, HT503, 603 & HT603 OPEN ARCH DIMENSIONS, ALLOWABLE MOVEMENTS* & PRESSURES†

Pipe Size (in)	Flange Outside Dia. (in)	Face to Face (in)	Overall Flange Thickness (in)		Bolt Circle Dia. (in)	No. of Holes	Bolt Hole Dia. (in)	Allowable Movements					Rated Working Pressure [†] (psig)	Minimum Burst Pressure [†] (psig)	503, HT503 Vacuum (in Hg)	603, HT603 Vacuum (in Hg)
			Steel	Ductile				Axial Compression (in)	Axial Extension (in)	Lateral Deflection (in)	Degrees Angular (degrees)	Degrees Torsional (degrees)				
1 1/2	5	14	7/8	1	37/8	4	5/8	21/4	11/2	11/2	28.5	7	150	450	15	30
2	6	14	7/8	1	43/4	4	3/4	21/4	11/2	11/2	24.5	7	150	450	15	30
2 1/2	7	14	7/8	1	51/2	4	3/4	21/4	11/2	11/2	21.5	7	150	450	15	30
3	7 1/2	14	7/8	1	6	4	3/4	21/4	11/2	11/2	19.5	7	150	450	15	30
4	9	14	7/8	1	7 1/2	8	3/4	21/4	11/2	11/2	17.5	7	150	450	15	30
5	10	14	7/8	1	8 1/2	8	7/8	21/4	11/2	11/2	16.0	7	150	450	15	30
6	11	14	7/8	1	9 1/2	8	7/8	21/4	11/2	11/2	15.5	7	150	450	15	30
8	13 1/2	14	7/8	1	11 3/4	8	7/8	21/4	11/2	11/2	15.0	7	150	450	15	30
10	16	16	1	1 1/8	14 1/4	12	1	3	17/8	17/8	14.9	7	150	450	15	30
12	19	16	1	1 1/8	17	12	1	3	17/8	17/8	12.8	7	150	450	15	30
14	21	16	1	1 1/8	18 3/4	12	1 1/8	3	17/8	17/8	12.8	6	150	450	15	30
16	23 1/2	16	1	1 1/8	21 1/4	16	1 1/8	3	17/8	17/8	12.8	6	150	450	15	30
18	25	16	1 1/8	1 1/4	22 3/4	16	1 1/4	3	17/8	17/8	12.5	5	150	450	15	30
20	27 1/2	16	1 1/8	1 1/4	25	20	1 1/4	3	17/8	17/8	12.5	5	150	450	15	30
22	29 1/2	18	1 1/8	1 1/4	27 1/4	20	1 3/8	3 3/4	21/4	17/8	12.3	5	150	450	15	30
24	32	18	1 1/8	1 1/4	29 1/2	20	1 3/8	3 3/4	21/4	17/8	12.0	5	150	450	15	30
26	34 1/4	18	1 1/8	1 1/4	31 3/4	24	1 3/8	3 3/4	21/4	17/8	12.0	5	150	450	15	30
28	36 1/2	18	1 1/8	1 1/4	34	28	1 3/8	3 3/4	21/4	17/8	12.0	5	150	450	10	30
30	38 3/4	18	1 1/8	1 1/4	36	28	1 3/8	3 3/4	21/4	17/8	12.0	5	150	450	10	30
34	43 3/4	18	1 1/8	1 1/4	40 1/2	32	1 5/8	3 3/4	21/4	17/8	11.8	5	150	450	10	30
36	46	18	1 1/8	1 1/4	42 3/4	32	1 5/8	3 3/4	21/4	17/8	11.5	5	150	450	10	30
40	50 3/4	18	1 1/8	1 1/4	47 1/4	36	1 5/8	3 3/4	21/4	17/8	11.5	5	105	315	10	30
42	53	20	1 1/8	1 1/4	49 1/2	36	1 5/8	4 1/2	25/8	21/4	11.5	4	105	315	10	30
44	55 1/4	20	1 1/8	1 1/4	51 3/4	40	1 5/8	4 1/2	25/8	21/4	11.5	4	105	315	10	30
48	59 1/2	20	1 1/8	1 1/4	56	44	1 5/8	4 1/2	25/8	21/4	11.5	4	105	315	10	30
50	61 3/4	20	1 1/8	1 1/4	58 1/4	44	1 7/8	4 1/2	25/8	21/4	11.3	4	90	270	10	30
54	66 1/4	20	1 1/8	1 1/4	62 3/4	44	1 7/8	4 1/2	25/8	21/4	11.3	4	90	270	10	30
56	68 3/4	20	1 1/8	1 1/4	65	48	1 7/8	4 1/2	25/8	21/4	11.3	4	60	180	10	30
60	73	20	1 1/8	1 1/4	69 1/4	52	2	4 1/2	25/8	21/4	11.0	4	60	180	10	30
62	75 3/4	20	1 1/8	1 1/4	71 3/4	52	2	4 1/2	25/8	21/4	11.0	4	60	180	10	30
66	80	20	1 1/8	1 1/4	76	52	2	4 1/2	25/8	21/4	11.0	4	60	180	10	30
72	86 1/2	20	1 1/8	1 1/4	82 1/2	60	2	4 1/2	25/8	21/4	10.9	4	60	180	10	30
78	93	20	1 1/8	1 1/4	88 3/4	60	2 1/8	4 1/2	25/8	21/4	10.9	4	60	180	10	30
84	99 3/4	20	1 1/8	1 1/4	95 1/2	64	2 1/8	4 1/2	25/8	21/4	10.8	4	60	180	10	30
90	106 1/2	20	1 1/8	1 1/4	102 1/4	68	2 1/4	4 1/2	25/8	21/4	10.8	4	45	135	10	30
96	113 1/4	20	1 1/8	1 1/4	108 1/2	68	2 1/2	4 1/2	25/8	21/4	10.7	4	45	135	10	30
98	115 1/2	20	1 1/4	1 3/8	110 3/4	68	2 1/2	6 3/4	3	3 3/8	10.6	3	30	90	10	30
100	117 3/4	20	1 1/4	1 3/8	113	68	2 1/2	6 3/4	3	3 3/8	10.6	3	30	90	10	30
102	120	20	1 1/4	1 3/8	114 1/2	72	2 1/2	6 3/4	3	3 3/8	10.6	3	30	90	10	30
108	126 3/4	20	1 1/4	1 3/8	120 3/4	72	2 1/2	6 3/4	3	3 3/8	10.4	3	25	75	10	30
120	140 1/4	20	1 1/4	1 3/8	132 3/4	76	2 1/2	6 3/4	3	3 3/8	10.4	3	25	75	10	30
132	153 3/4	20	1 1/4	1 3/8	145 3/4	80	2 1/2	6 3/4	3	3 3/8	10.3	3	25	75	10	30
144	167 3/4	20	1 1/4	1 3/8	158 1/4	84	2 1/2	6 3/4	3	3 3/8	10.1	3	25	75	8	30

*Reduce movements 50% when using filled arches. †Higher pressure joints are special design- Advise factory of requirements.

4 ARCH
STYLE 504 & HT504, 604 & HT604

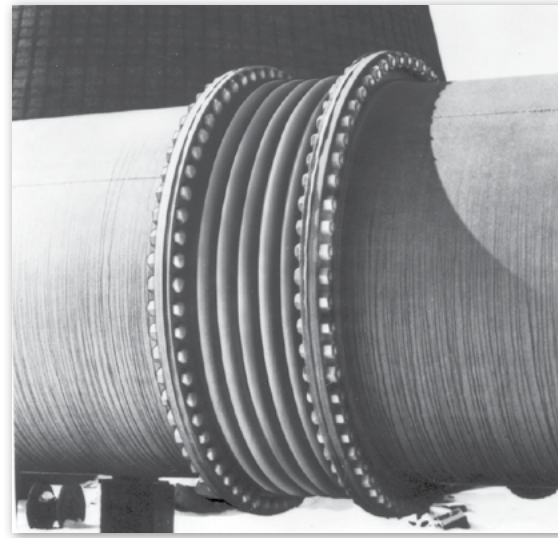
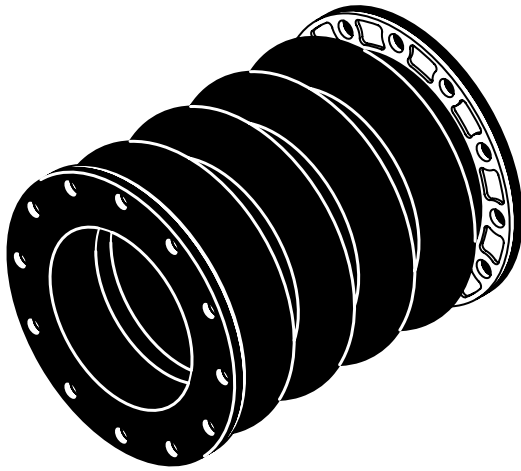

STYLE 504, HT504, 604 & HT604 OPEN ARCH DIMENSIONS, ALLOWABLE MOVEMENTS* & PRESSURES†

Pipe Size (in)	Flange Outside Dia. (in)	Face to Face (in)	Overall Flange Thickness (in)		Bolt Circle Dia. (in)	No. of Holes	Bolt Hole Dia. (in)	Allowable Movements					Rated Working Pressure [†] (psig)	Minimum Burst Pressure [†] (psig)	504, HT504 Vacuum (in Hg)	604, HT604 Vacuum (in Hg)
			Steel	Ductile				Axial Compression (in)	Axial Extension (in)	Lateral Deflection (in)	Degrees Angular (degrees)	Degrees Torsional (degrees)				
1 1/2	5	18	7/8	1	37/8	4	5/8	3	2	2	33.5	8	150	450	15	30
2	6	18	7/8	1	43/4	4	3/4	3	2	2	29.5	8	150	450	15	30
2 1/2	7	18	7/8	1	51/2	4	3/4	3	2	2	26.5	8	150	450	15	30
3	7 1/2	18	7/8	1	6	4	3/4	3	2	2	24.5	8	150	450	15	30
4	9	18	7/8	1	7 1/2	8	3/4	3	2	2	22.5	8	150	450	15	30
5	10	18	7/8	1	8 1/2	8	7/8	3	2	2	21.0	8	150	450	15	30
6	11	18	7/8	1	9 1/2	8	7/8	3	2	2	20.5	8	150	450	15	30
8	13 1/2	18	7/8	1	11 3/4	8	7/8	3	2	2	20.0	8	150	450	15	30
10	16	20	1	1 1/8	14 1/4	12	1	4	2 1/2	2 1/2	19.9	8	150	450	15	30
12	19	20	1	1 1/8	17	12	1	4	2 1/2	2 1/2	17.8	8	150	450	15	30
14	21	20	1	1 1/8	18 3/4	12	1 1/8	4	3	2 1/2	17.8	7	150	450	15	30
16	23 1/2	20	1	1 1/8	21 1/4	16	1 1/8	4	3	2 1/2	17.8	7	150	450	15	30
18	25	20	1 1/8	1 1/4	22 3/4	16	1 1/4	4	3	2 1/2	17.5	6	150	450	15	30
20	27 1/2	20	1 1/8	1 1/4	25	20	1 1/4	4	3	2 1/2	17.5	6	150	450	15	30
22	29 1/2	22	1 1/8	1 1/4	27 1/4	20	1 3/8	5	3	2 1/2	17.3	6	150	450	15	30
24	32	22	1 1/8	1 1/4	29 1/2	20	1 3/8	5	3	2 1/2	17.0	6	150	450	15	30
26	34 1/4	22	1 1/8	1 1/4	31 3/4	24	1 3/8	5	3	2 1/2	17.0	6	150	450	15	30
28	36 1/2	22	1 1/8	1 1/4	34	28	1 3/8	5	3	2 1/2	17.0	6	150	450	10	30
30	38 3/4	22	1 1/8	1 1/4	36	28	1 3/8	5	3 1/2	3	17.0	6	150	450	10	30
34	43 3/4	22	1 1/8	1 1/4	40 1/2	32	1 5/8	5	3 1/2	3	16.8	6	150	450	10	30
36	46	22	1 1/8	1 1/4	42 3/4	32	1 5/8	5	3 1/2	3	16.5	6	150	450	10	30
40	50 3/4	22	1 1/8	1 1/4	47 1/4	36	1 5/8	5	3 1/2	3	16.5	6	105	315	10	30
42	53	24	1 1/8	1 1/4	49 1/2	36	1 5/8	6	3 1/2	3	16.5	5	105	315	10	30
44	55 1/4	24	1 1/8	1 1/4	51 3/4	40	1 5/8	6	3 1/2	3	16.5	5	105	315	10	30
48	59 1/2	24	1 1/8	1 1/4	56	44	1 5/8	6	3 1/2	3	16.5	5	105	315	10	30
50	61 3/4	24	1 1/8	1 1/4	58 1/4	44	1 7/8	6	3 1/2	3	16.3	5	90	270	10	30
54	66 1/4	24	1 1/8	1 1/4	62 3/4	44	1 7/8	6	3 1/2	3	16.3	5	90	270	10	30
56	68 3/4	24	1 1/8	1 1/4	65	48	1 7/8	6	3 1/2	3	16.3	5	60	180	10	30
60	73	24	1 1/8	1 1/4	69 1/4	52	2	6	3 1/2	3	16.0	5	60	180	10	30
62	75 3/4	24	1 1/8	1 1/4	71 3/4	52	2	6	3 1/2	3	16.0	5	60	180	10	30
66	80	24	1 1/8	1 1/4	76	52	2	6	3 1/2	3	16.0	5	60	180	10	30
72	86 1/2	24	1 1/8	1 1/4	82 1/2	60	2	6	3 1/2	3	15.9	5	60	180	10	30
78	93	24	1 1/8	1 1/4	88 3/4	60	2 1/8	6	3 1/2	3	15.9	5	60	180	10	30
84	99 3/4	24	1 1/8	1 1/4	95 1/2	64	2 1/8	6	3 1/2	3	15.8	5	60	180	10	30
90	106 1/2	24	1 1/8	1 1/4	102 1/4	68	2 1/4	6	3 1/2	3	15.8	5	45	135	10	30
96	113 1/4	24	1 1/8	1 1/4	108 1/2	68	2 1/4	6	3 1/2	3	15.7	5	45	135	10	30
98	115 1/2	24	1 1/4	1 3/8	110 3/4	68	2 1/2	9	4	4 1/2	15.6	4	30	90	10	30
100	117 3/4	24	1 1/4	1 3/8	113	68	2 1/2	9	4	4 1/2	15.6	4	30	90	10	30
102	120	24	1 1/4	1 3/8	114 1/2	72	2 1/2	9	4	4 1/2	15.6	4	30	90	10	30
108	126 3/4	24	1 1/4	1 3/8	120 3/4	72	2 1/2	9	4	4 1/2	15.4	4	25	75	10	30
120	140 1/4	24	1 1/4	1 3/8	132 3/4	76	2 1/2	9	4	4 1/2	15.4	4	25	75	10	30
132	153 3/4	24	1 1/4	1 3/8	145 3/4	80	2 1/2	9	4	4 1/2	15.3	4	25	75	10	30
144	167 3/4	24	1 1/4	1 3/8	158 1/4	84	2 1/2	9	4	4 1/2	15.1	4	25	75	8	30

*Reduce movements 50% when using filled arches. †Higher pressure joints are special design- Advise factory of requirements.



Installation Instructions - 500, HT500, 600 & HT600

IMPORTANT

- a. Do not weld in vicinity of expansion joint.
- b. Do not lift expansion joint by bolt holes; use padded sling.
- c. Never operate joint beyond its rated temperature, pressure or movements (see pages 9•93 - 9•96).
- d. Mating flanges must be flat or raised face. Do not mate with contoured flanges such as victaulic or similar configurations.
- e. Check for chemical compatibility with the ordered material.

-
1. All pipelines must be properly supported, anchored and guided so joints do not carry pipe or thrust loads.
 2. If piping is not anchored, control units must be used.
 3. Use of control units and thrust sleeves will not protect piping in anchored situations. Expansion joints must be selected for adequate movement capability.
 4. Piping should be aligned. Misalignment or improper face to face openings will reduce the allowable motion by the initial inaccuracy. Joints are often damaged if forced into position.
 5. Apply a thin film of graphite, dispersed in glycerin or water to the rubber flange face and between the backup ring and the back of the rubber flange, to prevent rubber adhering to the mating metal flange for easy removal of the joint without damage. No gaskets or gasket sealants should be used.
 6. Install bolts from the backup ring side to avoid bolt projections cutting the cover. If this is impossible, bolts should not project more than 1/8" past the nuts. Use washers over split ring gaps.
 7. Unlike tightening hard flanges, tighten bolts in series making at least three complete circuits of each flange. Flanges will accept full bolt torque.

8. After system is in service at operating temperature, check the flange bolts and retighten as necessary. Repeat in a few weeks or if leaks develop. It is normal for rubber flanges to relax after initial installation. Check periodically until bolts remain tight.
9. Any gouges or cuts in the cover caused during installation should be inspected and sealed.
10. If control rods are used, the clearance between the rubber washer and the gusset plate should be the allowable axial elongation, if the expansion joint is installed at the published face to face. We do not recommend precompression or extension as general practice, but if the joint is compressed, the gap is increased by the decrease in length. If installed elongated, the gap is decreased by the increase in length. Hold one end against the control rod plate and the washers against the nut on the other end when measuring the gap.

EXAMPLES

6" - 500 - Allowable Extension 1/2"

1. 6" - 500 is installed at published 6" face to face dimension.
Set control rod gap to 1/2".
2. 6" - 500 is installed 53/4" long.
Set control rod gap to 1/2" plus 1/4" = 3/4"
3. 6" - 500 is installed 61/4" long.
Set control rod gap to 1/2" minus 1/4" = 1/4"
11. If compression sleeves are used, no setting is required as they are furnished to proper length.
12. If these instructions are not strictly adhered to, the Mercer One-Year Guarantee is void. Joints should be checked at a maximum of one year intervals for signs of cracking and hardening. Expansion joints showing these symptoms must be replaced regardless of age.