

# LOW SPRING RATE, LARGE MOVEMENT EXPANSION JOINTS

Series  
**1000**

**1 ARCH**  
Style 1001 High Movement Expansion Joint

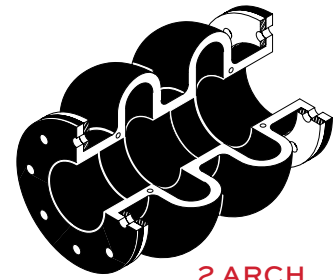
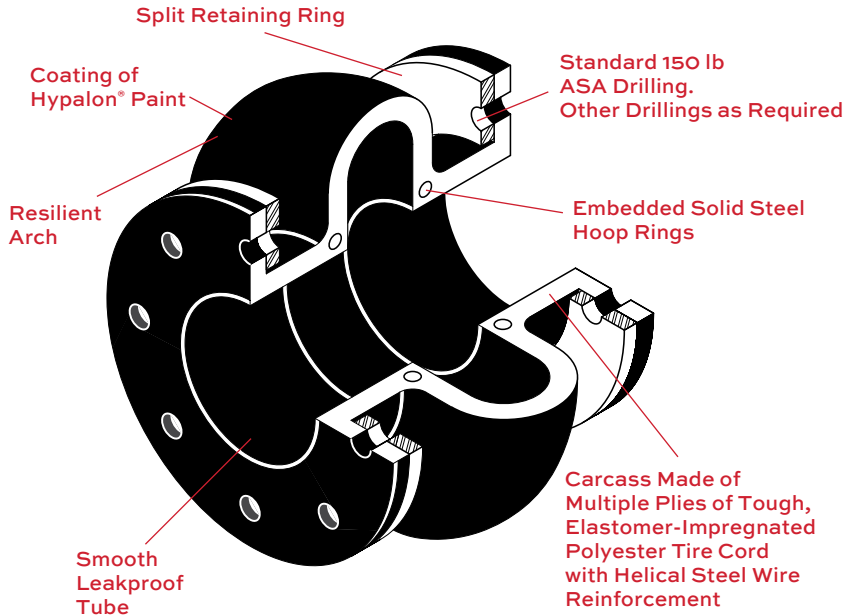

**2 ARCH**  
Style 1002

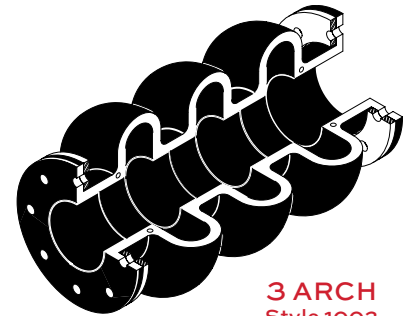

**3 ARCH**  
Style 1003

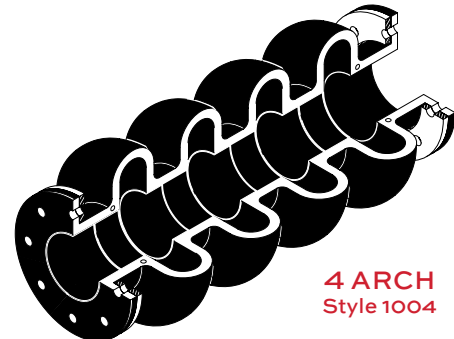

**4 ARCH**  
Style 1004

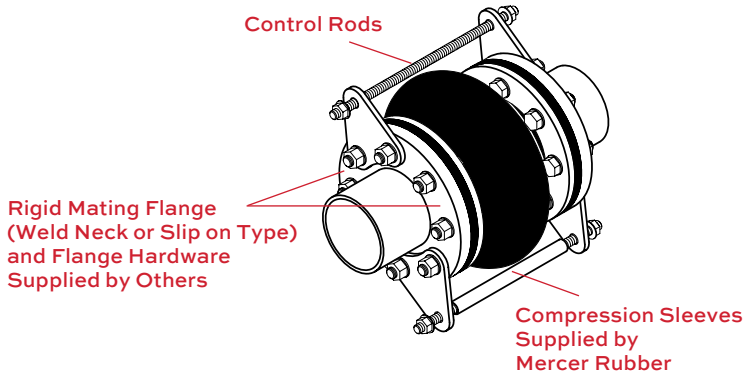

**EXPANSION JOINTS INSTALLED IN PIPING SYSTEMS THAT ARE ANCHORED ON BOTH SIDES OF THE JOINT.**

No control rods are necessary. If control rods are installed as a safety measure, the locking nuts must be backed off with a clearance equal to the specified axial movement. The expansion joint will exert a thrust force on the anchors. To calculate pressure thrust on anchors use the following equation:

**Pressure Thrust = (Pressure Thrust Area) x (Rated Working Pressure)**

**EXPANSION JOINTS INSTALLED IN UNANCHORED PIPING OR CONNECTED TO ISOLATED EQUIPMENT.**

Control rods are necessary. Once control rods are installed the joint will no longer act as an expansion joint, since the pressure will extend the joint to the nuts of the control rods. The joint will no longer take up axial motion. It will make up for misalignment, transverse and possibly angular motion. The nuts of the control rods should be threaded against control rod gussets, thereby preventing joint from extending.

Expansion joint flanges must be in contact with a flat faced or 1/16" standard raised face flange. Depressions or protrusions typical of vitaulic or similar type flanges must be covered with a steel spacer flange first. Rubber flanges will not retain loose elements in valve bodies that rely on contact with a steel flange. A steel spacer flange must be inserted between the rubber expansion joint and the valve body.

**SERIES 1000**

**MATERIAL AVAILABILITY & OPERATING TEMPERATURES**

Series 1000	Standard Materials		Max. Oper. Temp.
	Tube	Cover	
B	Butyl	Butyl	250°F
E	EPDM	EPDM	250°F
H	Hypalon®	Hypalon®	225°F
HN	Hypalon®	Neoprene	225°F
N	Neoprene	Neoprene	225°F
NH	Neoprene	Hypalon®	225°F
Ni	Nitrile	Nitrile	210°F
NiN	Nitrile	Neoprene	210°F
NR	Neoprene	Natural	225°F
R	Natural	Natural	180°F
RN	Natural	Neoprene	180°F
V	Viton®	Viton®	250°F

\*Food Grade Rubber Available.



**1 ARCH**  
Style 1001

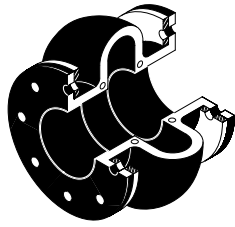

**STYLE 1001 DIMENSIONS**  
ALLOWABLE MOVEMENTS & OPERATING PRESSURES

Pipe Size I.D. (in)	Face to Face FF (in)	Allowable Movements			Rated Working Pressure (psi)	Vacuum Rating (in Hg)	Compression Spring Rate (lb/in)	Thrust Area (sq in)
		Axial Compression (in)	Axial Extension (in)	Lateral Deflection (in)				
2	15	4	1 1/2	1 1/2	150	5	68	33
2 1/2	15	4	1 1/2	1 1/2	150	5	83	38
3	15	4	1 1/2	1 1/2	150	5	100	44
4	15	4	1 1/2	1 1/2	150	5	133	56
5	15	4	1 1/2	1 1/2	120	5	168	70
6	15	4	1 1/2	1 1/2	100	5	200	95
8	15	4	1 1/2	1 1/2	75	5	265	132
10	15	4	1 1/2	1 1/2	60	5	333	176
12	15	4	1 1/2	1 1/2	50	5	400	226
14	15	4	1 1/2	1 1/2	45	5	465	283
16	15	4	1 1/2	1 1/2	40	5	533	346
18	15	4	1 1/2	1 1/2	35	5	593	415
20	15	4	1 1/2	1 1/2	30	5	665	490

Total Force Required for Rated Movements shown (Compression) = Axial Compression x Compression Spring Rate.  
Example: Style 1001 Size 12 , 4 x 400 = 1600

**2 ARCH**  
Style 1002

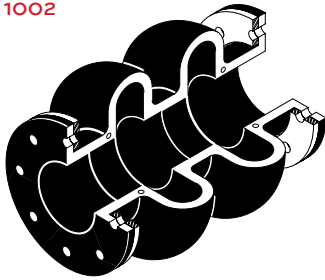

**STYLE 1002 DIMENSIONS**  
ALLOWABLE MOVEMENTS & OPERATING PRESSURES

Pipe Size I.D. (in)	Face to Face FF (in)	Allowable Movements			Rated Working Pressure (psi)	Vacuum Rating (in Hg)	Compression Spring Rate (lb/in)	Thrust Area (sq in)
		Axial Compression (in)	Axial Extension (in)	Lateral Deflection (in)				
2	21	8	3	3	150	5	34	33
2 1/2	21	8	3	3	150	5	42	38
3	21	8	3	3	150	5	50	44
4	21	8	3	3	150	5	67	56
5	21	8	3	3	120	5	84	70
6	21	8	3	3	100	5	100	95
8	21	8	3	3	75	5	133	132
10	21	8	3	3	60	5	167	176
12	21	8	3	3	50	5	200	226
14	21	8	3	3	45	5	233	283
16	21	8	3	3	40	5	267	346
18	21	8	3	3	35	5	297	415
20	21	8	3	3	30	5	333	490

Total Force Required for Rated Movements shown (Compression) = Axial Compression x Compression Spring Rate.  
Example: Style 1002 Size 12 , 8 x 200 = 1600

**3 ARCH**  
Style 1003

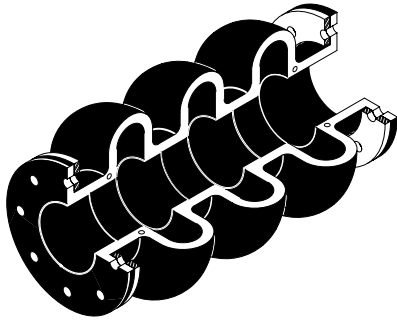

**STYLE 1003 DIMENSIONS**

**ALLOWABLE MOVEMENTS & OPERATING PRESSURES**

Pipe Size I.D. (in)	Face to Face FF (in)	Allowable Movements			Rated Working Pressure (psi)	Vacuum Rating (in Hg)	Compression Spring Rate (lb/in)	Thrust Area (sq in)
		Axial Compression (in)	Axial Extension (in)	Lateral Deflection (in)				
2	28	12	4 1/2	4 1/2	150	5	23	33
2 1/2	28	12	4 1/2	4 1/2	150	5	28	38
3	28	12	4 1/2	4 1/2	150	5	33	44
4	28	12	4 1/2	4 1/2	150	5	44	56
5	28	12	4 1/2	4 1/2	120	5	56	70
6	28	12	4 1/2	4 1/2	100	5	67	95
8	28	12	4 1/2	4 1/2	75	5	88	132
10	28	12	4 1/2	4 1/2	60	5	111	176
12	28	12	4 1/2	4 1/2	50	5	133	226
14	28	12	4 1/2	4 1/2	45	5	155	283
16	28	12	4 1/2	4 1/2	40	5	178	346
18	28	12	4 1/2	4 1/2	35	5	198	415
20	28	12	4 1/2	4 1/2	30	5	222	490

Total Force Required for Rated Movements shown (Compression) = Axial Compression x Compression Spring Rate.  
Example: Style 1003 Size 12, 12 x 133 = 1596

**4 ARCH**  
Style 1004

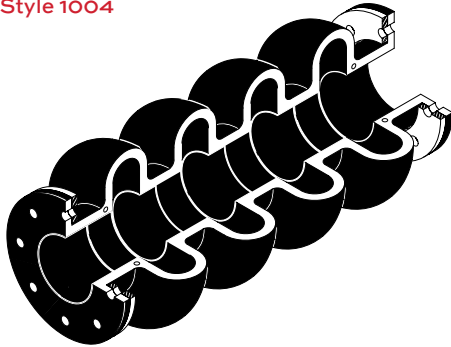

**STYLE 1004 DIMENSIONS**

**ALLOWABLE MOVEMENTS & OPERATING PRESSURES**

Pipe Size I.D. (in)	Face to Face FF (in)	Allowable Movements			Rated Working Pressure (psi)	Vacuum Rating (in Hg)	Compression Spring Rate (lb/in)	Thrust Area (sq in)
		Axial Compression (in)	Axial Extension (in)	Lateral Deflection (in)				
2	34	16	6	6	150	5	17	33
2 1/2	34	16	6	6	150	5	21	38
3	34	16	6	6	150	5	25	44
4	34	16	6	6	150	5	33	56
5	34	16	6	6	120	5	42	70
6	34	16	6	6	100	5	50	95
8	34	16	6	6	75	5	66	132
10	34	16	6	6	60	5	83	176
12	34	16	6	6	50	5	100	226
14	34	16	6	6	45	5	116	283
16	34	16	6	6	40	5	133	346
18	34	16	6	6	35	5	148	415
20	34	16	6	6	30	5	166	490

Total Force Required for Rated Movements shown (Compression) = Axial Compression x Compression Spring Rate.  
Example: Style 1004 Size 12, 16 x 100 = 1600